



Micro Switch(2nd Edition) Micro Smart Switch(2nd Edition)

(In-Wall Z-Wave Appliance Module w/ optional Energy Monitor)
View the expanded manual: → <http://aeot.ec/spprt/micro switch>



Introduction:

The Aeotec by Aeon Labs Micro Smart Switch G2 is a low-cost Z-Wave appliance module specifically used to enable Z-Wave command and control (on/off) for existing in-wall switches. It can also report immediate wattage consumption or kWh energy usage over a period of time.

The wireless module is powered from the mains supply and is a three-wire design which requires a neutral connection. In the event of power failure, non-volatile memory retains all programmed information relating to the units operating status.

Products that are Z-Wave certified can be used and communicate with other Z-Wave certified devices.

IMPORTANT:

A licensed electrician with knowledge and understanding of electrical systems and electrical safety should complete the electrical installation inside the main circuit box (usually located outside of your house).

In-Wall Electrical Installation Instructions:

Step 1 **IMPORTANT:** The electricity to the circuit must be shut off during installation for safety and to ensure that wires are not short circuited during installation which will cause damage to the Micro Module.

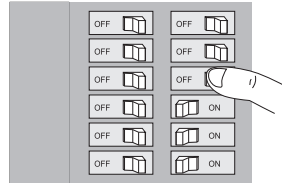

Step 2 **Dismounting In Wall Box.**

1. Remove the two screws securing the cover plate.
2. Remove the wall switch cover plate.
3. Remove the two screws securing the wall switch to the wall box. Disconnect both wires from the wall switch.

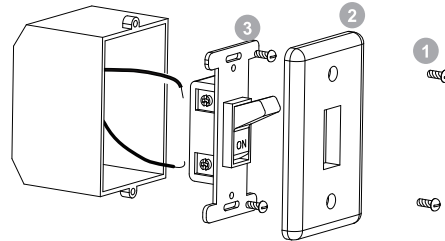

Step 3 **Preparing and Connecting Wires** must

first be powered by a 3-wire system in order to operate. The wiring diagram is as follows:

Note: The "3V Out" terminal should be used only with the Aeon Micro Touch.

Diagram: 2-Way connecting

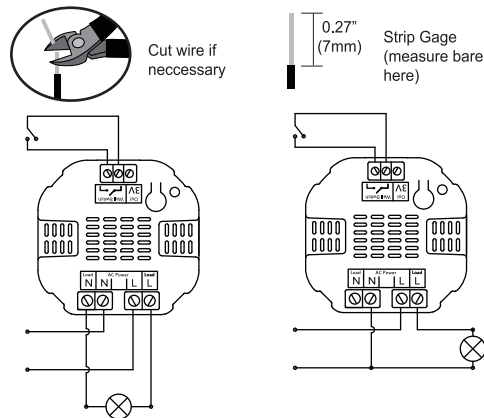
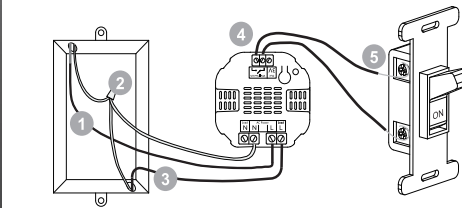
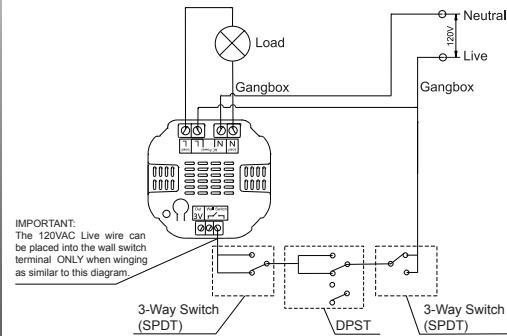

Diagram: 3-Way connecting



1. Live/Hot Wire (Black) Connection – Connect the Live/Hot Wire to the 'L' AC Power terminal on the Micro Smart Switch G2.
2. Neutral Wire (White) Connection – Connect the Neutral Wire to the 'N' AC Power terminal on the Micro Smart Switch G2. If this wire is not present in the gang box, a neutral wire must be pulled into the box.
3. Load Wire Connection – Connect the Load wire to the 'L' Load terminal on the Micro Smart Switch G2.
4. Wall Switch Wire Connection – Connect two 18 AWG copper wires to the Wall Switch terminal on the Micro Smart Switch G2.
5. Wall Switch Wire Connection – Connect the wires from item #4 to the external Wall Switch.

Step 4 **Mounting In Wall Box.**

1. Position all wires to provide room for the device. Place Micro Smart Switch G2 inside the wall box towards the back of the box.
2. Position the antenna towards the back of the box, away from all other wiring.
3. Reinstall the wall switch to the wall box.
4. Reinstall the cover plate onto the wall box.

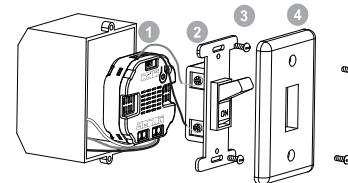

Step 5 **Restore Power**
Restore power at the circuit breaker or fuse.
Installation is complete.

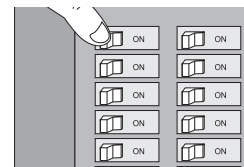

Z-Wave Network Instructions:

The Aeotec by Aeon Labs Micro Smart Switch G2 must be paired (included) into a Z-Wave network before it can receive Z-Wave commands to turn on/off and report its energy usage. The Micro Smart Switch G2 can only communicate to devices within its own Z-Wave network.

Adding/Including/Pairing the Micro Smart Switch G2 into a Z-Wave Network

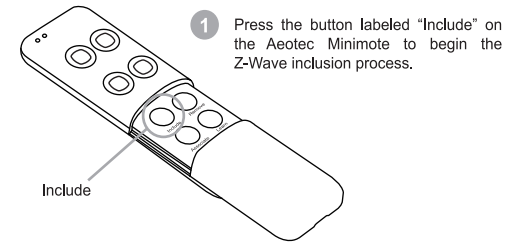

- 1 Press the button labeled "Include" on the Aeotec Minimote to begin the Z-Wave inclusion process.

Note: To include the Aeotec Micro Smart Switch G2 with other controllers, please consult the operation manual for these controllers on how to include Z-Wave products into an existing network.

- 2 While the Micro Smart Switch G2 is powered in a 3-wire system, the external switch/button can be toggled to initiate pairing into the Z-Wave network. Or the internal button can be pressed to initiate pairing into the Z-Wave network, if Micro Smart Switch G2 was not put into in-wall box.

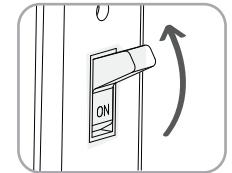

Removing/Resetting the Micro Smart Switch G2 from your Z-Wave Network

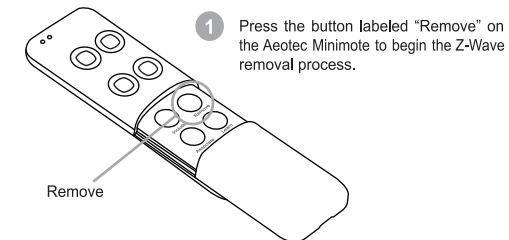

- 1 Press the button labeled "Remove" on the Aeotec Minimote to begin the Z-Wave removal process.

Note: To remove the Aeotec Micro Smart Switch G2 from other controllers, please consult the operation manual for these controllers on how to remove Z-Wave products from an existing network.

- 2 While the Micro Smart Switch G2 is powered in a 3-wire system, the external switch/button can be toggled 10 times in quick succession to initiate removing from the Z-Wave network. Or the internal button can be pushed to initiate pairing into the Z-Wave network, if Micro Smart Switch G2 was not put into in-wall box.

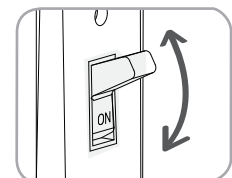

Turning On/Off the Micro Smart Switch G2

Use any of the below methods to toggle the load on the Micro Smart Switch G2.

- Through the usage of Z-Wave commands built into Z-Wave certified control points. (The specific Z-Wave commands supporting this function are the Basic Command Class, Binary Switch Command Class, and Scene Activation Command Class) Please consult the operation manual for these controllers for specific instructions on controlling the Micro Smart Switch G2.
- Via toggles on the connected wall switch.
- Pressing the button on the Micro Smart Switch G2 will toggle power flow (on/off) through the Micro Smart Switch G2.

Change Mode on the External Switch/Button Control

• The Aeotec by Aeon Labs Micro Smart Switch G2 can be locally controlled via 2-state (flip/flop) external wall switch, momentary push button, or a 3-way wall switch. To automatically detect and set the mode to the appropriate type of wall switch wired into the Micro, toggle the button on the wall switch once and allow 2 seconds for the Micro to detect the type of wall switch (the LED will go from blinking to solid).

• If the wrong wall switch mode was detected, you may cycle through the wall switch modes by pressing and holding the button for 5 seconds (after 5 seconds, the LED will go from solid to blinking). The available modes are: 2-state (flip/flop) wall switch mode, momentary push button mode, and 3-way wall switch mode. Alternatively pressing and holding the button 15 seconds (the LED will go from blinking slowly to blinking fast), the external switch mode will reset to "unknown" wall switch mode and another auto-detect may be preformed by toggling the wall switch once.

Note: The wall switch mode may also be set through the usage of Z-Wave radio commands (Configuration Command Class).

Monitoring Energy Consumption

The Aeotec by Aeon Labs Micro Smart Switch G2 can report wattage energy usage or kWh energy usage to a Z-Wave control point when requested. If this function is supported by the control points, the energy consumption will be displayed in the user interface of the control points. (The specific Z-Wave commands supporting energy monitoring are the Meter Command Class. Automatic reports are sent to association group 1, which is setup via the Association Command Class.) Please consult the operation manual for these control points for specific instructions on monitoring the Micro Smart Switch G2.

Note: The Micro Switch G2 (without the words "Smart") does not have the ability to monitor energy consumption.

Technical Specifications

- USA: 120V 60Hz input, 1200W or 10A max output.
- EU/AU/IN/BR/CN: 230V 50Hz input, 2300W or 10A max output.

Warranty

Aeon Labs warrants to the original purchaser of Products that for the Warranty Period (as defined below), the Products will be free from material defects in materials and workmanship. The foregoing warranty is subject to the proper installation, operation and maintenance of the Products in accordance with installation instructions and the operating manual supplied to Customer. Warranty claims must be made by Customer in writing within thirty (30) days of the manifestation of a problem. Aeon Labs' sole obligation under the foregoing warranty is, at Aeon Labs' option, to repair, replace or correct any such defect that was present at the time of delivery, or to remove the Products and to refund the purchase price to Customer.

The "Warranty Period" begins on the date the Products is delivered and continues for 12 months.

Any repairs under this warranty must be conducted by an authorized Aeon Labs service representative and under Aeon Labs' RMA policy. Any repairs conducted by unauthorized persons shall void this warranty.

Excluded from the warranty are problems due to accidents, acts of God, civil or military authority, civil disturbance, war, strikes, fires, other catastrophes, misuse, misapplication, storage damage, negligence, electrical power problems, or modification to the Products or its components.

Aeon Labs does not authorize any person or party to assume or create for it any other obligation or liability in connection with the Products except as set forth herein.

Aeon Labs will pass on to Customer all manufacturers' Material warranties to the extent that they are transferable, but will not independently warrant any Material.

Customer must prepay shipping and transportation charges for returned Products, and insure the shipment or accept the risk of loss or damage during such shipment and transportation. Aeon Labs will ship the repaired or replacement products to Customer freight prepaid.

Customer shall indemnify, defend, and hold Aeon Labs and Aeon Labs' affiliates, shareholders, directors, officers, employees, contractors, agents and other representatives harmless from all demands, claims, actions, causes of action, proceedings, suits, assessments, losses, damages, liabilities, settlements, judgments, fines, penalties, interest, costs and expenses (including fees and disbursements of counsel) of every kind (i) based upon personal injury or death or injury to property to the extent any of the foregoing is proximately caused either by a defective product (including strict liability in tort) or by the negligent or willful acts or omissions of Customer or its officers, employees, subcontractors or agents, and/or (ii) arising from or relating to any actual or alleged infringement or misappropriation of any patent, trademark, mask work, copyright, trade secret or any actual or alleged violation of any other intellectual property rights arising from or in connection with the products, except to the extent that such infringement exists as a result of Aeon Labs' manufacturing processes.

IN NO EVENT SHALL AEON LABS BE LIABLE FOR ANY INDIRECT, INCIDENTAL, PUNITIVE, SPECIAL OR CONSEQUENTIAL DAMAGES, OR DAMAGES FOR LOSS OF PROFITS, REVENUE, OR USE INCURRED BY CUSTOMER OR ANY THIRD PARTY, WHETHER IN AN ACTION IN CONTRACT, OR TORT, OR OTHERWISE EVEN IF ADVISED OF THE POSSIBILITY OF SUCH DAMAGES. AEON LABS' LIABILITY AND CUSTOMER'S EXCLUSIVE REMEDY FOR ANY CAUSE OF ACTION ARISING IN CONNECTION WITH THIS AGREEMENT OR THE SALE OR USE OF THE PRODUCTS, WHETHER BASED ON NEGLIGENCE, STRICT LIABILITY, BREACH OF WARRANTY, BREACH OF AGREEMENT, OR EQUITABLE PRINCIPLES, IS EXPRESSLY LIMITED TO, AT AEOTEC'S OPTION, REPLACEMENT OF, OR REPAYMENT OF THE PURCHASE PRICE FOR THAT PORTION OF PRODUCTS WITH RESPECT TO WHICH DAMAGES ARE CLAIMED. ALL CLAIMS OF ANY KIND ARISING IN CONNECTION WITH THIS AGREEMENT OR THE SALE OR USE OF PRODUCTS SHALL BE DEEMED WAIVED UNLESS MADE IN WRITING WITHIN THIRTY (30) DAYS FROM AEON LABS' DELIVERY, OR THE DATE FIXED FOR DELIVERY IN THE EVENT OF NONDELIVERY.

THE INDEMNITY AND WARRANTY IN ABOVE ARE EXCLUSIVE AND IN LIEU OF ALL OTHER INDEMNITIES OR WARRANTIES, WHETHER EXPRESS OR IMPLIED, INCLUDING THE IMPLIED WARRANTIES OF MERCHANTABILITY AND FITNESS FOR A PARTICULAR PURPOSE.

FCC NOTICE (For USA):

THE MANUFACTURER IS NOT RESPONSIBLE FOR ANY RADIO OR TV INTERFERENCE CAUSED BY UNAUTHORIZED MODIFICATIONS TO THIS EQUIPMENT. SUCH MODIFICATIONS COULD VOID THE USER'S AUTHORITY TO OPERATE THE EQUIPMENT.

STORE INDOORS WHEN NOT IN USE. SUITABLE FOR DRY LOCATIONS. DO NOT IMMERSE IN WATER. NOT FOR USE WHERE DIRECTLY EXPOSED TO WATER.

This device complies with Part 15 of the FCC Rules. Operation is subject to the following two conditions:

1. This device may not cause harmful interference, and
2. This device must accept any interference received, including interference that may cause undesired operation. This equipment has been tested and found to comply with the limits for a Class B digital device, pursuant to part 15 of the FCC Rules. These limits are designed to provide reasonable protection against harmful interference in a residential installation. This equipment generates, uses and can radiate radio frequency energy and, if not installed and used in accordance with the instructions, may cause harmful interference to radio communications. However, there is no guarantee that interference will not occur in a particular installation. If this equipment does cause harmful interference to radio or television reception, which can be determined by turning the equipment off and on, the user is encouraged to try to correct the interference by one or more of the following measures:

- Reorient or relocate the receiving antenna.
- Increase the separation between the equipment and receiver.
- Connect the equipment into an outlet on a circuit different from that to which the receiver is connected.
- Consult the dealer or an experienced radio/TV technician for help.

UL NOTICE (For USA):

1. Install only in a UL Listed junction box sized 3X2X2.75 inch (75X50X70mm) or larger, minimum Volume 14 in³ (230 cm³).
2. Use Copper Conductors Only.
3. CAUTION - Risk of Electric Shock - More than one disconnect switch may be required to de-energize the equipment before servicing.
4. WARNING - This device shall not be used in combination with a wall switch controlling a receptacle.

Warning:

Do not dispose of electrical appliances as unsorted municipal waste. Use separate collection facilities.

Contact your local government for information regarding the collection systems available.

Certifications (regional):



Version:501001800001-AA

www.aeotec.com

